

Instructions for Installation

HeatLink® PEX Compression Couplings (69000 Series)

Protection

If the brass coupling is to be buried or embedded in concrete, it must be wrapped with heat or cold shrink tube.



Assembly

Step 1. Ensure that both PEX tube ends have been cut at a 90° angle.

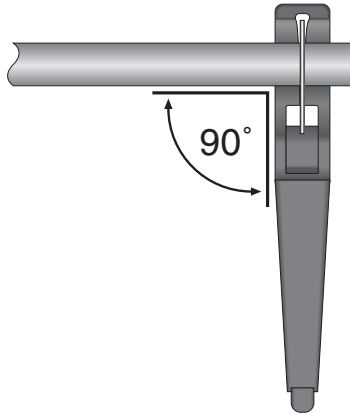

Step 2. Disassemble coupling by unscrewing the nut and removing the split ring ferrule from both sides.

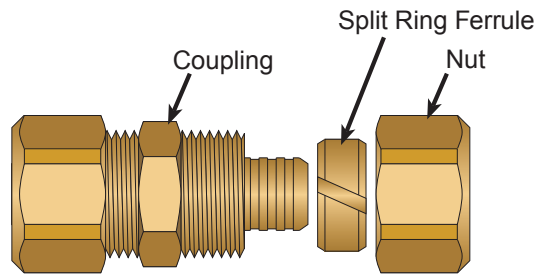

Step 3. Fit the nut over one of the PEX tube end.

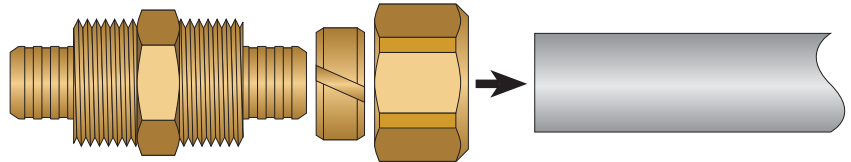

Step 4. Place the split ring ferrule on the PEX tube.

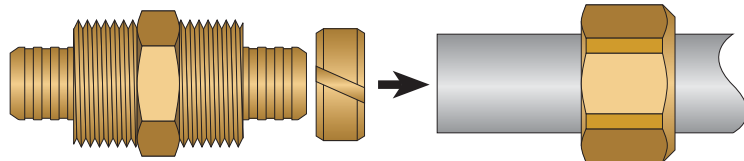

Step 5. Fit the PEX onto the coupling as far as possible (ie. up to the line as indicated).

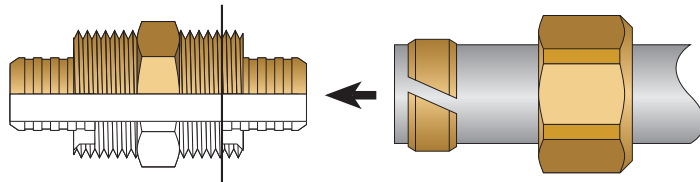

Step 6. Using two wrenches tighten the nut onto the coupling.

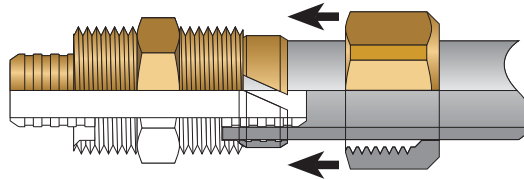

Step 7. If applicable, put the shrink tube over the assembly.

Step 8. Repeat steps 3 through 6 with the other PEX tube.

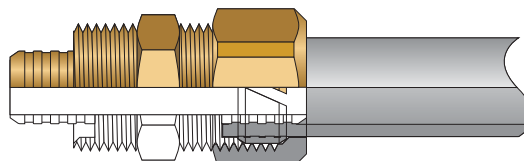

Step 9. If applicable, position the shrink tube and seal it.